

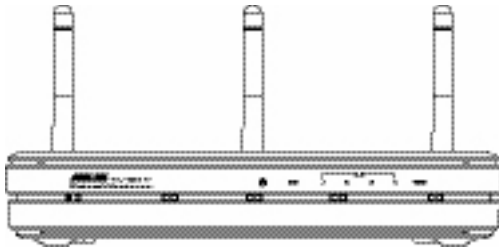

WL-500W SuperSpeed N Wireless Multi-Function Router



User Manual

Manufacturer Contact Information

ASUSTeK COMPUTER INC. (Asia-Pacific)

Company address: 15 Li-Te Road, Beitou, Taipei 11259

General (tel): +886-2-2894-3447 Web site address: www.asus.com.tw

General (fax): +886-2-2894-7798 General email: info@asus.com.tw

ASUS COMPUTER INTERNATIONAL (America)

Company address: 44370 Nobel Drive, Fremont, CA 94538, USA

General (fax): +1-510-608-4555 Web site address: usa.asus.com

Technical support

General support: +1-502-995-0883 Support (fax): +1-502-933-8713

Online support: <http://vip.asus.com/eservice/techserv.aspx>

ASUS COMPUTER GmbH (Germany & Austria)

Company address: Harkort Str. 25, D-40880 Ratingen, Germany

General (tel): +49-2102-95990 Web site address: www.asus.com.de

General (fax): +49-2102-959911 Online contact: www.asus.com.de/sales

Technical support

Components: +49-2102-95990 Online support: www.asus.com.de/support

Notebook: +49-2102-959910 Support (fax): +49-2102-959911



Table of contents

1. Package contents	3
2. Connecting ADSL modem and wireless router	3
1) Cable connection	3
2) Status indicators	4
3) Wall mount option	4
3. Getting started	5
1) Wired connection	5
2) Wireless Connection	5
3) Setting IP address for wired or wireless client	5
4) Configuring the wireless router	6
5) Quick setup	7
4. Wireless router features	12
1) Choosing an appropriate operation mode	12
2) Setting up wireless encryption	13
3) Setting up virtual server in your LAN	14
4) Setting up virtual DMZ in your LAN	15
5) Setting up DDNS	15
6) Setting up Bandwidth Management	19
5. Application features	22
1) Sharing USB storage	22
2) Setting up FTP site	24
3) Download Master	25
4) Web camera	26
5) Sharing USB printer	29
6. Setting up using ASUS utility	32
1) Utility Installation for WL-500W	32
2) EZSetup	33



7. Troubleshooting	35
8. Appendix	37



1. Package contents

- WL-500W wireless router x 1
- Power adapter x 1
- Utility CD x 1
- RJ45 cable x 1
- Quick Start Guide x 1

2. Connecting ADSL modem and wireless router

1) Cable connection

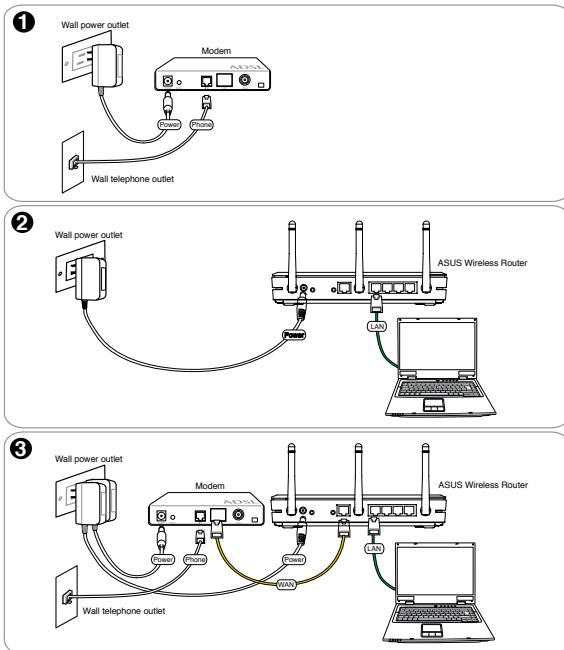

2) Status indicators

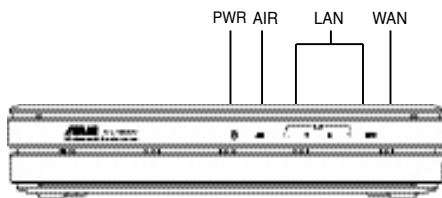

PWR (Power)

Off	No power
On	System ready
Flashing-slow	Firmware upgrade failed
Flashing-quick	EZsetup processing

AIR (Wireless Network)

Off	No power
On	Wireless system ready
Flashing	Transmitting or receiving data (wireless)

WAN (Wide Area Network)

Off	No power or no physical connection
On	Has physical connection to an Ethernet network
Flashing	Transmitting or receiving data (through Ethernet cable)

LAN 1-4 (Local Area Network)

Off	No power or no physical connection
On	Has physical connection to an Ethernet network
Flashing	Transmitting or receiving data (through Ethernet cable)

3) Wall mount option

The ASUS WL-500W Wireless Router is designed to sit on a raised flat surface like a file cabinet or book shelf. The unit may also be converted for mounting to a wall or ceiling.

Follow these steps to mount the ASUS Wireless Router to a wall:

1. Look on the underside for the two mounting hooks.
2. Mark two upper holes in a flat surface.
3. Tighten two screws until only 1/4" is showing.
4. Latch the hooks of the ASUS Wireless Router onto the screws.

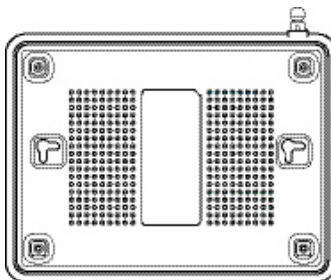

Note: Re-adjust the screws if you cannot latch the ASUS Wireless Router onto the screws or if it is too loose.



3. Getting started

The ASUS WL-500W Wireless Router can meet various working scenarios with proper configuration. The default settings of the wireless router may need change so as to meet your individual needs. Therefore, before using the ASUS Wireless Router, check the basic settings to make sure they all work in your environment.

ASUS provides a utility named EZSetup for fast wireless configuration. If you would like to use EZSetup for your wireless network configuration, refer to chapter 6 for details.



Note: Wired connection for initial configuration is recommended to avoid possible setup problems due to wireless uncertainty.

1) Wired connection

The WL-500W Wireless Router is supplied with an Ethernet cable in the package. The wireless router has an integrated auto-crossover function. Thus, you can either use straight-through or crossover cable for wired connection. Plug one end of the cable to the LAN port on the rear panel of the router and the other end to the Ethernet port on your PC.

2) Wireless Connection

For establishing wireless connection, you need an IEEE 802.11b/g compatible WLAN card. Refer to your wireless adapter user manual for wireless connection procedures. By default, the SSID of ASUS Wireless Router is "default" (in lower case), encryption is disabled and open system authentication is used.

3) Setting IP address for wired or wireless client

To access the WL-500W Wireless Router, you must have correct TCP/IP settings on your wired or wireless clients. Set the IP addresses of the clients within the same subnet of WL-500W.

Getting an IP address automatically

The WL-500W Wireless Router integrates DHCP server functions, thus, your PC gets an IP address automatically.



Note: Before rebooting your PC, switch ON the wireless router and make sure the router is in ready state.

Setting up the IP address manually

To manually set the IP address, you need to know the default settings of the wireless router:

- IP address 192.168.1.1
- Subnet Mask 255.255.255.0





To set up the connection with a manually assigned IP address, the address of your PC and the wireless router must be within the same subnet:

- IP address: 192.168.1.xxx (xxx can be any number between 2 and 254. Make sure the IP address is not used by other device)
- Subnet Mask: 255.255.255.0 (same as WL-500W)
- Gateway: 192.168.1.1 (IP address of WL-500W)
- DNS: 192.168.1.1 (WL-500W), or assign a known DNS server in your network.



4) Configuring the wireless router

Follow the steps below to enter the Web configuration interface of WL-500W.

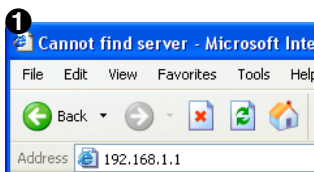

Enter the following address in your web browser: <http://192.168.1.1>

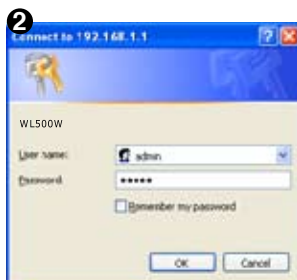

Defaults

User name: admin Password: admin

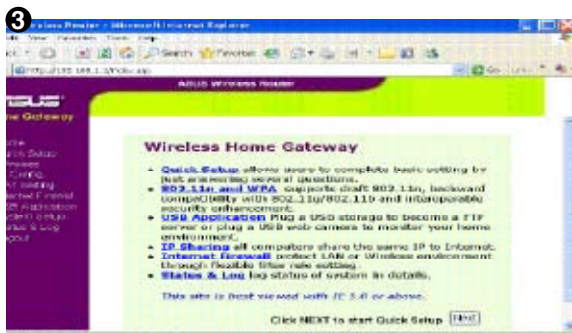

After logging in, you can see the ASUS Wireless Router home page.

The homepage displays quick links to configure the main features of the wireless router.



5) Quick setup

To start quick setup, click **Next** to enter the "Quick Setup" page. Follow the instructions to setup the ASUS Wireless Router.

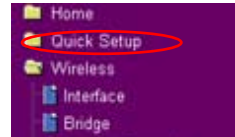

1. Select your time zone and click **Next**.



2. ASUS wireless router supports five types of ISP services: cable, PPPoE, PPTP, static WAN IP, and Telstra BigPond. Select your connection type and click **Next** to continue.



Cable or dynamic IP user

If you are using services provided by cable ISP, select **Cable Modem or other connection that gets IP automatically**. If your ISP provides you with the hostname, the MAC address, and the heartbeat server address, fill these information into the boxes on the setting page; if not, click **Next** to skip this step.



PPPoE user

If you use PPPoE service, select **ADSL connection that requires username and password**. It is known as PPPoE. You need to input the username and password provided by your ISP. Click **Next** to continue.





PPTP user

If you are using PPTP services, select **ADSL connection that requires username, password and IP address**. Fill in the username, the password and the IP address provided by your ISP into the fields. Click **Next** to continue.

Set Your Account to ISP

If you apply an account with dynamic IP, you must get user account and password from your ISP. Please fill the data into the following fields carefully. Or, if you apply an ADSL account with static IP, just ignore user name and password information.

User Name: herk036@adsl-comfort

Password: *****

Next Back

WAN IP Setting

For PPTP setting for ADSL to connect to Internet through WAN port.

Get IP automatically? Yes No

IP Address: 210.28.111.12

Subnet Mask: 255.255.255.0

Default Gateway: 210.28.111.1

Get DNS Server automatically? Yes No

DNS Server 1: 100.96.1.1

DNS Server 2:

Next Back

Static IP user

If you are using ADSL or other connection type that uses static IP address, select **ADSL or other connection type that uses static IP address**. Input the IP address, the subnet mask, and the default gateway provided by your ISP. You can specify DNS servers, or get DNS information automatically.

WAN IP Setting

For PPTP setting for ADSL to connect to Internet through WAN port.

Get IP automatically? Yes No

IP Address: 210.28.111.12

Subnet Mask: 255.255.255.0

Default Gateway: 210.28.111.1

Get DNS Server automatically? Yes No

DNS Server 1: 100.96.1.1

DNS Server 2:

Next Back

- After the connection type setting is complete, you are to set up your wireless interface. Specify to your wireless router an SSID (Service Set Identifier), which is a unique identifier attached to packets sent over WLAN. This identifier emulates a password when a device attempts to communicate with your wireless router via WLAN.

Configure Wireless Interface

First step to set your wireless interface is to give it a name, called SSID. In addition, if you would like to protect transmitted data, please select the Security Level and assign a password for authentication and data encryption if it is required.

SSID: WLAN

Security Level: WPA2-PSK

WEP Key 1 (64 or 128 bits):

WEP Key 2 (64 or 128 bits):

WEP Key 3 (64 or 128 bits):

WEP Key 4 (64 or 128 bits):

Key Index:

Next Back

If you want to protect transmitted data, select a **Security Level** to enable encryption methods.

Medium: Only users with the same WEP key settings can connect to your wireless router and transmit data using 64bits or 128bits WEP key encryption.

High: Only users with the same WPA pre-shared key settings can connect to your wireless router and transmit data using TKIP encryption.



- Input four sets of WEP keys in the WEP Key fields (10 hexadecimal digits for WEP 64bits, 26 hexadecimal digits for WEP 128bits). You can also let the system generate the keys by inputting a Passphrase. Record the Passphrase and the WEP keys in your notebook, then click **Finish**.

For example, if we select WEP 64bits encryption mode and input 11111 as the Passphrase, the WEP Keys are generated automatically.



- Click **Save&Restart** to restart the wireless router and activate the new settings.



Note: We recommend using WL-100W wireless adapters to connect WL-500W so as to achieve high speed data transmission.

- To connect the wireless router from a wireless client, you can use Windows® Wireless Zero Configuration service to set up the connection. If you use ASUS Wireless Card on your computer, you can use the One Touch Wizard utility supplied in WLAN Card support CD for wireless connection.

Configuring ASUS WLAN Card with One Touch Wizard

If you have installed ASUS wireless card together with its utilities and drives on your PC, click **Start -> All Programs -> ASUS Utility-> WLAN Card -> One Touch Wizard** to launch the One Touch Wizard utility.





- 1) Select **Connect to an existing wireless LAN (Station)** radio button and click **Next** to continue.



- 2) One Touch Wizard searches and displays the available APs in the **Available Networks** list. Select WL-500W and press **Next** to continue.



- 3) Set the authentication and encryption of your WLAN card the same with those at WL-500W. In the previous steps the **Key Length** is **64 bits**, **Passphrase** is **11111**. Click **Next** to continue.



- 4) It takes several seconds for the wireless card to associate with WL-500W. Press **Next** to setup TCP/IP for your WLAN Card.



- 5) Setup the IP address of the WLAN Card according to your network condition. After the setup is complete, click **Finish** to exit the One Touch Wizard.

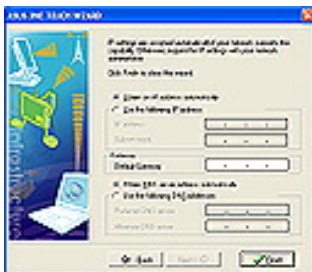



Configuring WLAN card with Windows® WZC service

If you use non-ASUS wireless card, you can set up the wireless connection with Windows® Wireless Zero Configuration (WZC) service.

- 1) Double-click the wireless network icon on the task bar to view available networks. Select your wireless router and click **Connect**.
- 2) Input the 10-digit keys you have set on the wireless router and click **Connect**. The connection is complete within several seconds.



7. Configuring advanced features

To view and adjust other settings of the wireless router, enter the Web configuration page of WL-500W. Click on items on the menu to open a submenu and follow the instructions to setup the router. Tips show up when you move your cursor over each item.





4. Wireless router features

This chapter provides setup examples of some frequently used router features. You can set up these features via your Web browser.

1) Choosing an appropriate operation mode

ASUS WL-500W Wireless Router supports three operation modes: home gateway, router, and access point. Click **System Setup** -> **Operation mode** to open the configuration page.

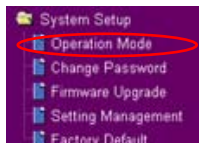

Home gateway mode is for home or SOHO users who want to connect to their ISPs for Internet services. In this operation mode, NAT, WAN connection, Internet firewall functions are supported.

Router mode is for office use where multiple routers and switches co-exist. You can set up routing policies in this mode; however, NAT function is disabled.

Access point mode works when you setup WL-500W as a wireless bridge. In this mode, all Ethernet ports on WL-500W (4 LAN ports and 1 WAN port) are recognized as LAN ports. WAN connection, NAT, and Internet firewall functions are disabled in access point mode.

Select a proper mode which complies to your network scenario and press **Apply** button, and then you can continue to set up the advanced features for your WL-500W.

System Setup - Operation Mode	
ASUS Wireless Router supports three operation modes to meet different requirements from different group of people. Please select the mode that match your situation.	
<input checked="" type="radio"/> Home Gateway	<p>In this mode, we suppose you use ASUS Wireless Router to connect to Internet through ADSL or Cable Modem. And, there are many people in your environment share the same IP to ISP.</p> <p>Explaining with technical terms, gateway mode is , NAT is enabled, WAN connection is allowed by using PPPoE, or DHCP client, or static IP. In addition, some features which are useful for home user, such as UPnP and DDNS, are supported.</p>
<input type="radio"/> Router	<p>In Router mode, we suppose you use ASUS Wireless Router to connect to LAN in your company. So, you can set up routing protocol to meet your requirement in office.</p> <p>Explaining with technical terms, router mode is, NAT is disabled, static routing protocol are allowed to set.</p>
<input type="radio"/> Access Point	<p>In Access Point mode, all 5 Ethernet ports and wireless devices are set to locate in the same local area network. Those WAN related functions are not supported here.</p> <p>Explaining with technical terms, access point mode is, NAT is disabled, one wan port and four lan ports of ASUS Wireless Router are bridged together.</p>
<input type="button" value="Apply"/>	



2) Setting up wireless encryption

WL-500W provides a set of encryption and authentication methods to meet the different demands of home, SOHO, and enterprise users. Before setting up encryption and authentication for WL-500W, contact your network administrator for advice.

Click **Wireless -> Interface** to open the configuration page.



Wireless - Interface	
SSID:	Default
Channel:	Auto
Wireless Mode:	Auto <input type="checkbox"/> Protection
Bandwidth:	40MHz
Authentication Method:	Open System or Shared Key
WPA Encryption:	TKIP
WPA Pre-Shared Key:	
WEP Encryption:	None
Passphrase:	
WEP Key 1 (10 or 26 hex digits):	
WEP Key 2 (10 or 26 hex digits):	
WEP Key 3 (10 or 26 hex digits):	
WEP Key 4 (10 or 26 hex digits):	



Note: For 802.11n performance, select 40MHz bandwidth. Channel option will depend on the bandwidth that you select.

Encryption

The encryption modes supported by WL-500W are: WEP (64bits), WEP (128bits), TKIP, AES, and TKIP+AES.

WEP stands for Wired Equivalent Privacy, it uses 64bits or 128bits static keys to encrypt the data for wireless transmission. To setup WEP keys, set **WEP Encryption** to **WEP-64bits** or **WEP-128bits**, then manually type in four sets **WEP Keys** (10 hexadecimal digits for 64-bit key or 26 hexadecimal digits for 128-bit key). You can also let the system generate the keys by entering a **Passphrase**.

TKIP stands for Temporal Key Integrity Protocol. TKIP dynamically generates unique keys to encrypt every data packet in a wireless session.

AES stands for Advanced Encryption Standard. This solution offers stronger protection and increases the complexity of wireless encryption.

TKIP+AES is used when both WPA and WPA2 clients co-exist in the wireless network.

Authentication

The authentication methods supported by WL-500W include: Open, shared key, WPA-PSK, WPA, and Radius with 80.211x.

Open: This option disables authentication protection for wireless network. Under Open mode, any IEEE802.11b/g client can connect to your wireless network.

Shared: This mode uses the WEP keys currently in use for authentication.

WPA/WPA2 and WPA-PSK/WPA2-PSK: WPA stands for WiFi-Protected Access. WPA provides two security modes: WPA for enterprise network, and WPA-PSK for home and SOHO users. For enterprise network, WPA uses the already existing RADIUS server for authentication; for home and SOHO user, it provides Pre-Shared Key (PSK) for user identification. The Pre-Shared Key consists of 8 to 64 characters.

Radius with 802.1X: Similar with WPA, this solution also uses RADIUS server for authentication. The difference lays on the encryption methods: WPA adopts TKIP or AES encryption methods, while Radius with 802.1X does not provide encryption.

When authentication and encryption are set, click **Finish** to save the settings and restart the wireless router.

3) Setting up virtual server in your LAN

Virtual server is a Network Address Translation (NAT) function which turns a computer within a LAN into a server by allowing data packets of certain service, such as HTTP, from Internet.

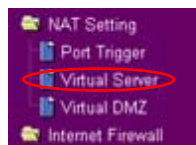

1. Click **Virtual Server** in NAT Setting folder to open the NAT configuration page.

2. Select **Yes** to enable virtual server. For example, if host 192.168.1.100 is the FTP server that the user will access, it means all packets from Internet with destination port as 21 are to be directed to the host. Set Well-known Application to FTP. Port range to 21, Local IP to the host IP, Local Port to 21, Protocol to TCP.

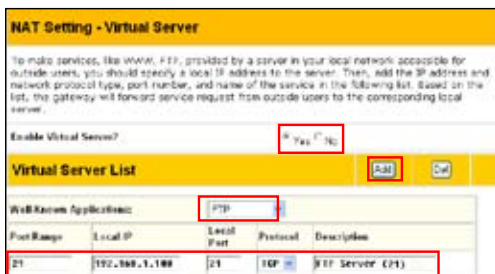

3. Click **Finish**.

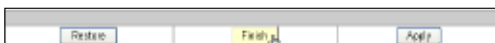

4. Click **Save & Restart** to restart the wireless router and activate the settings.





4) Setting up virtual DMZ in your LAN

To expose an internal host to the Internet and make all services provided by this host available to outside users, enable Virtual DMZ function to open all ports of the host. This function is useful when the host plays multiple roles such as HTTP server and FTP server. However, in doing this, your network becomes less secure.

1. Click **Virtual DMZ** in the NAT Setting menu.

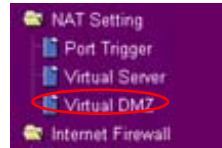

2. Enter the IP address of the host and click **Finish**.



3. Click **Save & Restart** to restart the wireless router and activate the settings.



5) Setting up DDNS

DNS enables host who uses static IP address to associate with a domain name; for dynamic IP users, they can also associate with a domain name via dynamic DNS (DDNS). DDNS requires registering and account-creating at DDNS service providers' website. The DDNS server updates your IP address information once you are assigned to a new IP address. Thus, the Internet user can always access your network.

1. Click **Miscellaneous** from IP Config folder.



2. Select **Yes** to enable the DDNS service. If you do not have a DDNS account, click **Free Trial** to register for a trial account.





- After clicking Free Trial, you are directed to the homepage of www.DynDNS.org, where you can register and apply for DDNS service.

Read the policy and select "I have read..."



- Enter your user name, e-mail address, password, then click **Create Account**.

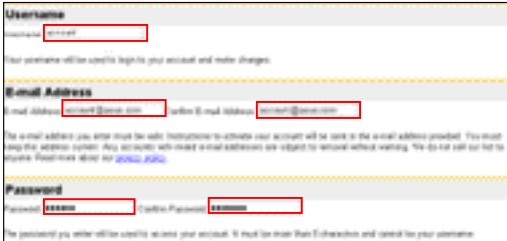

- A message prompts out informing that your account has been created. An E-mail is sent to your mailbox. Open your mailbox and read the mail.



- You can find the activation letter in your E-mail box. Click the hyperlink.

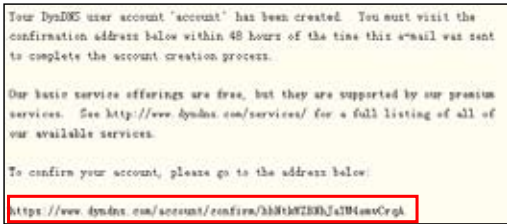

- The link directs you to a login page. Click **login**.



- Enter the user name and password then click **Login**.





9. After logging in, you can see this welcome message.



10. Select **Services** tab.



11. Click **Add Dynamic DNS Host**.

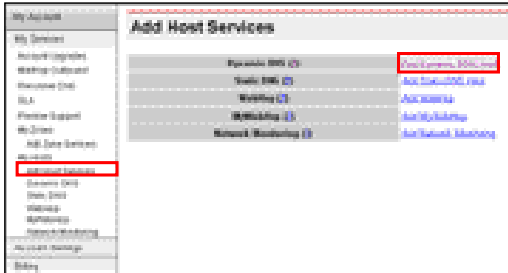

12. Enter the host name then click **Add Host**.

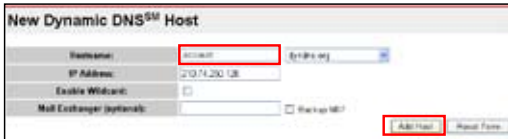

13. You can see this message when your hostname is successfully created.

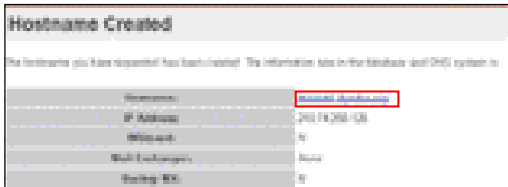



- 14. Fill the account information into the DDNS setting fields of your wireless router.

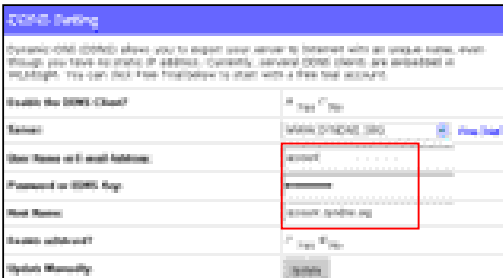

- 15. Click **Finish**.



- 16. Click **Save & Restart** to restart the wireless router and activate the settings.



- 17. Verify whether DDNS is working. Click **Start** menu and select **Run**. Type **cmd** and click **OK** to open the CLI console.

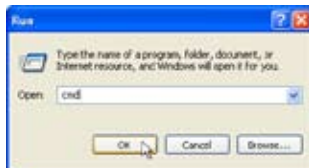

- 18. Type **ping account.dyndns.org**. **dyndns.org** (your DDNS domain name). If you can see the reply like what is shown in the right picture, DDNS is working correctly.

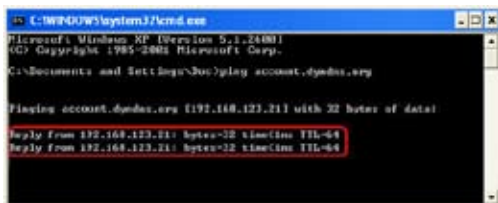



6) Setting up Bandwidth Management

Bandwidth Management provides a mechanism that controls the traffic of your network. To set up bandwidth management:

1. Click **Basic Config** page in Bandwidth Management folder. In this page you can see four buttons including **Gaming Blaster**, **Internet Application**, **500W FTP Server**, and **VOIP/Video Streaming**. In this page, you can click each item to set its priority higher. After you click each item, the letters on the button turns yellow (see figures below) and the green bar behind it automatically grows longer, indicating its bandwidth status is the first priority. Click **Finish** and **Apply** to complete the configuration. The following figures shows different bandwidth priority settings:

Gaming Blaster

Bandwidth Management – Bandwidth On Demand

Under Gaming Blaster, WL500W will handle gaming traffic at first priority. You can then enjoy latency-free gaming experiences!

Priority

Gaming Blaster Low

Internet Application

FTP Server

Voip/Video Streaming

Restore Finish Apply

Internet Application

Bandwidth Management – Bandwidth On Demand

Under this mode, e-mail, web browsing, and other Internet applications will be handled at first priority.

Priority

Gaming Blaster

Internet Application

FTP Server

Voip/Video Streaming

Restore Finish Apply



500W FTP Server

Bandwidth Management – Bandwidth On Demand

Under this mode, the files downloaded/uploaded to WL500W's USB FTP server will be sent through without interruption! Otherwise, you can reserve more bandwidth for this service at "User Specify Service" page!

Priority

Low

Gaming Blaster

Internet Application

FTP Server

Voip/Video Streaming

Restore Finish Apply

After you applying the **500W FTP Server** settings, a screen appears asking you to do further configuration:

User Specify Rule List Add Del

A maximum 8 entries can be configured, 1 is the highest priority and 8 is the lowest.

Service Name	Source IP Address	Destination Port	Priority
			1

The "FTP Server" mode was enabled! You can use the scroll bar to reserve more upload bandwidth for WL500W's FTP Server Service. If you set "0%", it means that FTP server has only high priority but no reserved bandwidth.

Reserved Bandwidth: %



VOIP/Video Streaming

Bandwidth Management – Bandwidth On Demand

Under this mode, WL500W will firstly manage all the audio/video traffic. No more latency when talking over IP phone or watching movies online!

Priority

Gaming Blaster Low

Internet Application

FTP Server

Voip/Video Streaming

Restore Finish Apply

2. You can also configure the bandwidth manually by clicking "User Specify Services". Input the **IP address**, **destination port** and choose the **priority status** from the drop-down list.

User Specify Rule List Add Del

A maximum 8 entries can be configured, 1 is the highest priority and 8 is the lowest.

Service Name	Source IP Address	Destination Port	Priority
			1

The "FTP Server" mode was enable! You can use the scroll bar to reserve more upload bandwidth for WL500W's FTP Server Service. If you set "0%", it means that FTP server has only high priority but no reserved bandwidth.

Reserved Bandwidth: %

Long Packet Fragmentation

5. Application features

ASUS WL-500W Wireless Router provides two USB2.0 ports for connecting the USB storage, the USB camera, and the USB printer. Thus, you can monitor the working environment, share data and printer with both wired and wireless users in your network. Furthermore, WL-500W provides a download utility -- the Download Master -- to facilitate and share the download files.



Warning: Before unplugging the USB storage disk from WL-500W, you must eject the disk in **Status & Log -> External USB Disk** page to prevent data corruption.



Note: Before applying change and rebooting WL-500W, make sure all USB applications are disabled, it would take more than 20 seconds for WL-500W to reboot.

1) Sharing USB storage

To use this feature, you need to plug a USB hard disk to the USB2.0 port on the rear panel of WL-500W. Make sure the hard disk is formatted and partitioned properly.



Note: FAT32 has a 2GB file size limitation and do not support files above that size. If you want to use files of above 2GB, you must format the disk to EXT2 file system.

Creating user account

To share the data in the USB storage, you need to create user accounts first.

1. Click **USB Application -> User List** in the left side menu to open the configuration page.

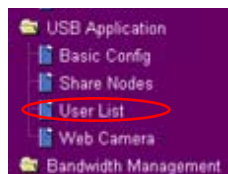

2. Input **User Name** and **Password** for the accounts. Click **Add** to add the account to the list.



3. To delete an account, select the account from the list and click **Del**.
4. Click **Apply** to apply the changes and restart the wireless router.

Creating share folder and access right

You can create a new share folder or share an existing folder in your hard disk.

1. Click **USB Application -> Share Nodes** in the left side menu to open the configuration page.

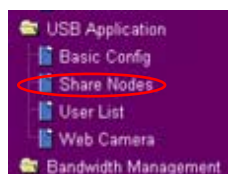



- Click **Add** to add a share folder.



- Select the folder you want to share from Folder Manager and click **Ok**. To create a share folder, input the folder name in **Add Folder** field and press **Add**.



- Define the access right for the share folder by appoint **User Name** and **Access Right**. Click **Add** to add the access right rule. When finished, click **Apply** to save the configuration.

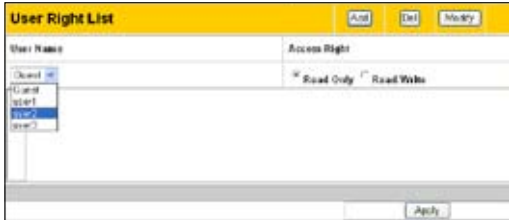

- Set Network Neighbourhood Mode to **Apply** rules in shared node list, Work Group to **WORKGROUP** to enable all computers within WORKGROUP to access WL-500W USB storage.



- Click **Finish**.



- Click **Save & Restart** to restart the wireless router and activate the settings.

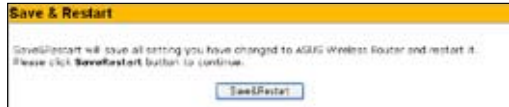

- Open **My Network Place** from a computer connected to WL-500W. Click **view work group computers**, you can see WL-500W in the **Workgroup** category. All files on the USB storage are ready for sharing.

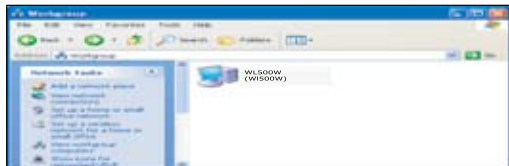

2) Setting up FTP site

WL-500W can also serve as an FTP site. You can make your FTP site accessible to all users, or set up an access policy to restrict anonymous login. To use this feature, you need to plug a USB storage disk to the USB2.0 port on the rear panel of WL-500W. Make sure the hard disk is formatted and partitioned properly.

1. To allow anonymous login: Set Network Neighborhood Mode to **Share all partitions in disk**, FTP Mode to **Login to first partition**. The anonymous login directory is the root directory of first partition.

To allow account login only: Set Network Neighborhood Mode to **Apply rules in shared node list**, FTP Mode to **Login to first matched shared node**. Click **Add** in the Share Node List to specify the access directory and access right of FTP account.

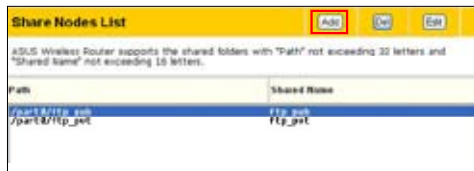
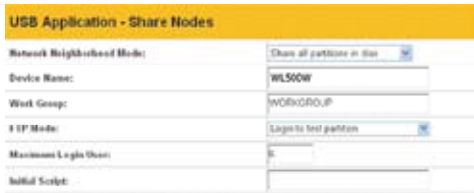

2. The **Maximum Login User** field specifies the maximum number of concurrent users. The default value is 6.

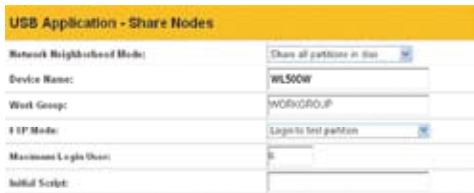

3. Click **Finish** to activate the settings and reboot. This process may take several minutes.



4. Type **ftp://192.168.1.1** into the address box of your Web browser and press Enter to login the FTP site.





3) Download Master

The Download Master helps to manage the download tasks without turning your computer on. To use this function, you need to: 1) mount a USB storage to WL-500W Wireless Router; and 2) install ASUS Utilities from the support CD. Refer to chapter 6 for utility installation procedures.

1. Click **Basic Config** page in USB Application folder.

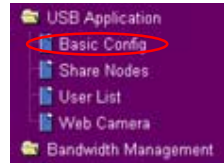

2. Set **Enable Download Master** to **Yes**. If you want to share the downloaded file with your LAN users, set **Enable Download Share** to **Yes**. Click **Finish** and save and restart the wireless router.

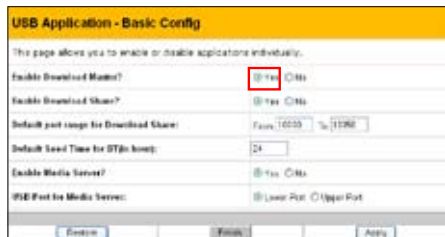

3. Open Download Master from Start -> All Programs -> ASUS Utility -> WL-500W Wireless Router -> Download Master. Click **File** -> **Connect** to associate with WL-500W.

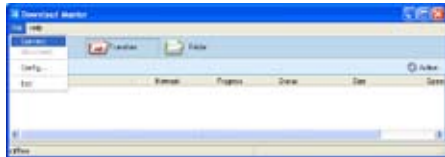

4. **HTTP download (1)**

Right click the download link on the Web page and click **Download using ASUS Download**. A window in step 5 appears to indicate download progress.

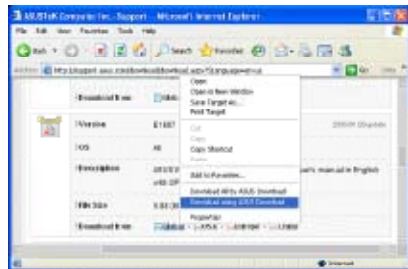

- HTTP download (2)**

Right click the download link on the Web page and click **Properties**. Copy the download **Address (URL)**.

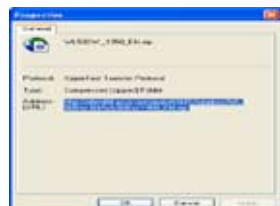



If you select **Download using ASUS Download**, you can see the download task is added to the **Transfer** list. The blue bars indicate the progress of download tasks.



If you copy the download address, click **Assign** button in the utility. Paste the address into **Getting File From** box, select **HTTP** from **Options**, and click **Download** button to start.

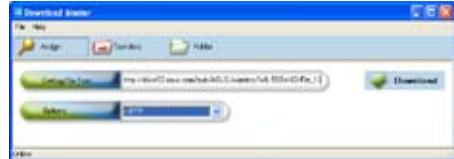

5. FTP download

Click **Transfer** button of the Download Master and select **FTP** in the **Options** field. Input the FTP site address, Port number, User Name, Password. Click **Download** to start.



6. BT download

Save the BT seed on your computer. Click **Transfer** button of the Download Master and select **BT** in the **Options** field. Click **Browse** to locate the seed file. Click **Download** to start.

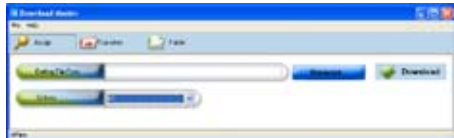

7. Click **Folder** button to view the download file. Open the **Complete** folder to view or copy the finished files to your local hard disk. The unfinished tasks are kept in **InComplete** folder.



4) Web camera

The ASUS Wireless Router implements several applications for a USB Web camera, enabling you to capture images and send them over the Internet. For this function, you need to plug a USB camera onto WL-500W and enable ActiveX for your Web browser.

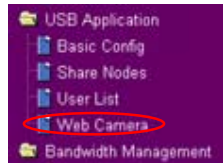

Web camera

1. Click **Web Camera** page in USB Application folder.
2. **Enable Web Camera** - Selecting LAN Only enables Web Camera for LAN users. Selecting LAN and WAN enableds Web Camera for both LAN users and WAN users through firewall.



Web Camera Mode - Select the appropriate camera mode from the drop down list. ActiveX Only enables user to execute ActiveX clients on an Windows® IE platform and get the best image quality. ActiveX and Refresh enables user to get a basic image on both IE and other browsers. Refresh Only provides to all users still images which are refreshed in a specified interval.

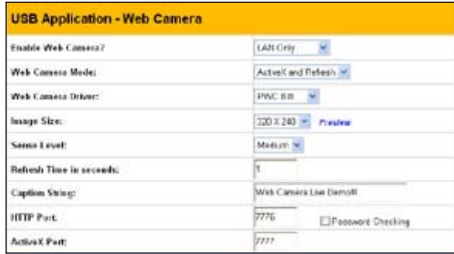

Web Camera Driver - When you plug a supported Web Camera into the USB2.0 port in the wireless router, the appropriate driver is selected automatically. Refer to the USB Web Camera support list on ASUS Website (www.asus.com) for supported Web Camera models.

Image Size - Select the image size from the drop down list. 320 x 240 provides a larger image while 160 x 120 provides faster transmission. Click Preview to see the effect.

Sense Level - This field indicates the sensitivity at which image movement is detected.

Refresh Time in Seconds - This field indicates the time interval in seconds in which the system reloads images. The range of values is 1~65535.

HTTP Port - This field indicates the port that HTTP server listens on to communicate. For example, by default, you can connect to your web camera by using `http://192.168.1.1:7776` without password checking. (The password checking field is unchecked.)

ActiveX Port - This field indicates the port that server listens on to communicate with ActiveX clients.

Enabling ActiveX for your IE

If you use Internet Explorer®, you need to enable ActiveX or the Web Camera cannot function properly. For clients using Netscape or other browsers, ignore this part.

1. Open Internet Explorer 5.0 or above on your computer, click **Tools -> Internet Options**.



3. Select **Security** tab and click **Custom Level** button.

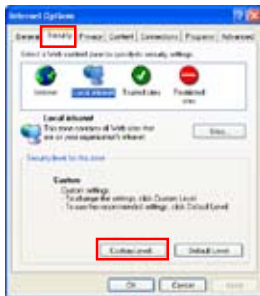

4. Enable the activeX controls and plug-ins. By default, these items are disabled.

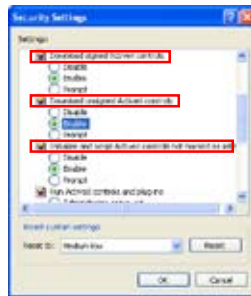



- By default, these three items are enabled. Enable them if changed.
- Click **Yes** to change the security settings.

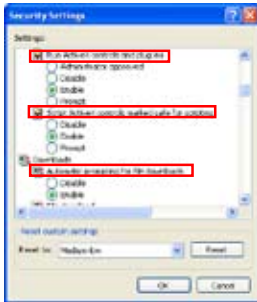

Enable Web Camera to WAN users

With proper setting to DDNS, you can monitor your working environment from anywhere on Internet, even if dynamic WAN IP address is used. If any motion is detected by the camera, WL-500W captures the images and send them to your appointed E-mail box. Refer to page 15-17 for DDNS setup procedures.

- Enable Security Mode?** -Select Yes to enable security function on the data and time you set below.

Date to Enable Security Mode - This field defines the date that Security Mode is enabled.

Time to Enable Security Mode - This field defines the time interval that Security Mode is enabled.

Security Mode Setting	
This function allows you to monitor your environment through Web Camera. If there is any motion detected, ASUS Wireless Router will try to alert you by means of e-mail.	
Enable Security Mode?	<input type="radio"/> Yes <input type="radio"/> No
Date to Enable Security Mode:	<input type="checkbox"/> Sun <input type="checkbox"/> Mon <input type="checkbox"/> Tue <input type="checkbox"/> Wed
Time to Enable Security Mode:	<input type="checkbox"/> Thu <input type="checkbox"/> Fri <input type="checkbox"/> Sat <input type="checkbox"/> Sun
Send to:	<input type="text"/>
Email Server:	<input type="text"/>
Subject:	Motion detector alert
Attach Image File?	<input type="checkbox"/> Yes <input type="checkbox"/> No

Send to - Input the E-mail address you wish WL-500W send the image to.

Email Server - This field indicates the E-mail server you use for exchanging E-mail. If you leave this field blank, WL-500W uses the mail server of your E-mail address in **Send to** field.

Subject - This field is for the subject of E-mail.

Attach Image File? - This field allows you to attach the captured image in the E-mail.

Remote monitors

This function allows you to monitor up to 6 Web Cameras in your LAN. You can enter the IP addresses of other ASUS Wireless Routers which have Web Camera attached.



Note: When enabling "LAN and WAN" remote control in the Wireless Router, packets from Internet with destination ports 8081 to 8086 will be forwarded to WL-500W in Remote Control fields. To make sure packets from WL-500W are routed back to Internet, you need to set a static route entry for WL-500W. The IP address and gateway address are same as the address of WL-500W.



Remote Site 1-6 - This field stands for the IP address and port number of Remote Site. The value of this field is [IP Address].[Connection Port].

Preview - Click Preview to see the view of all the Web Camera sites you set in Remote Site.

5) Sharing USB printer

You can connect a compatible USB printer to the USB2.0 port of WL-500W to share the printer with your LAN users. Follow the procedures below to setup your computers to utilize the printer server function of WL-500W.

Installing USB printer

Plug your USB printer to the USB2.0 port on WL-500W rear panel. To verify whether your printer is properly installed and to WL-500W Wireless router, click **Status & Log -> Status**. If **Printer Model** is correct and **Printer Status** is **On-Line**, you can share this printer within your LAN.



Note: Visit ASUS Website for compatible printer vendor and models.

Setting up printer client under Windows XP

Follow the steps below to install network printer on your clients.

1. Run Add Printer Wizard from **Start -> Printers and Faxes -> Add a printer**.
2. Select **Local printer attached to this computer** and click **Next**.

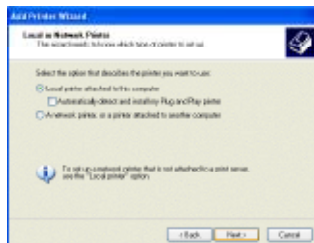
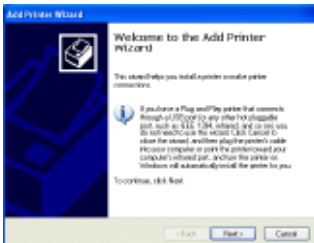



- 3. Select **Create a new port** and set Type of port to **Standard TCP/IP Port**, then click **Next**.

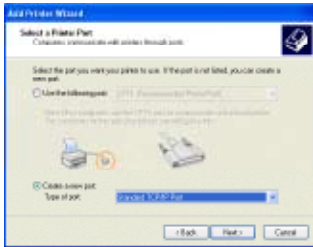

- 4. Click **Next** to setup TCP/IP port for accessing the network printer.

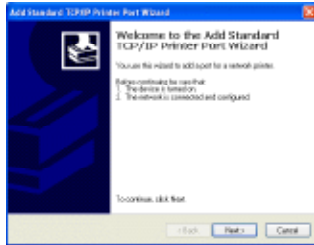

- 5. Input the IP address of WL-500W in the **Printer Name or IP Address** field and click **Next**.

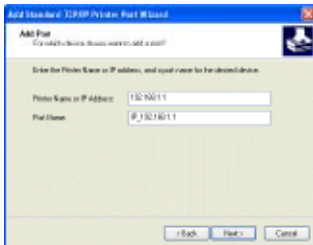

- 6. Select **Custom** and click **Settings**.

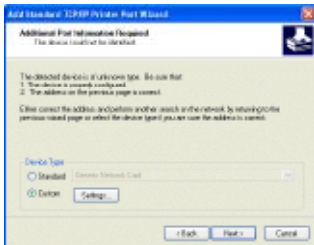

- 7. Set **Protocol** to **LPR** and type **LPRServer** in **Queue Name** field. Click **Next** to continue.



- 8. Press **Next** to finish standard TCP/IP port setting.

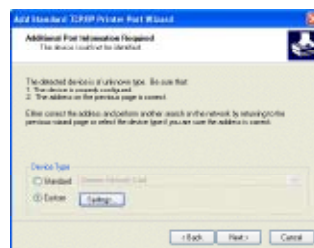



- Press **Finish** to complete the settings and return to Add Printer Wizard.

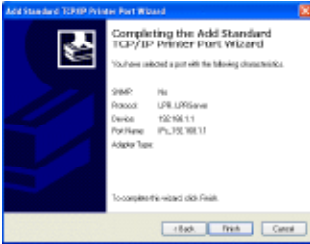

- Install printer driver from the vendor-model list. If your printer is not in the list, click **Have Disk** to manually assign the location of driver.

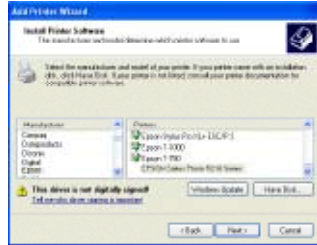

- Click **Next** to accept the default name for the printer.

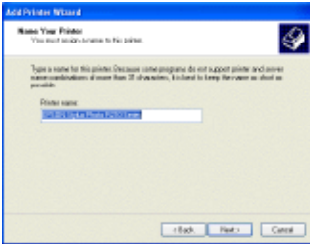

- Select **Yes** to print a test page. Click **Next** to print.

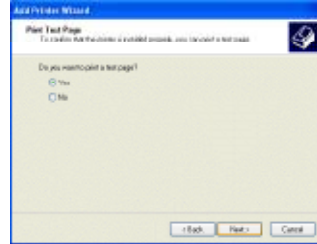

- The installation is complete. Click **Finish** to quit the Add Printer Wizard.

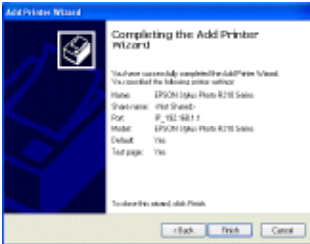

Note: If you have already installed the printer locally on your computer, right click the printer icon and select **Property -> Port** tab to add a standard TCP/IP port. Click **Add Port** then select **Standard TCP/IP Port** and click **New Port** button. Refer to step 5-8 for setting procedures.



Note: If you use Windows® 98 or ME which does not support Standard TCP/IP port, you need to use Remote Port which is supported by WL-500W.



6. Setting up using ASUS utility

1) Utility Installation for WL-500W

1. Click **Install ASUS Wireless Router Utilities** to run the setup installation program.
2. Click **Next** to continue.

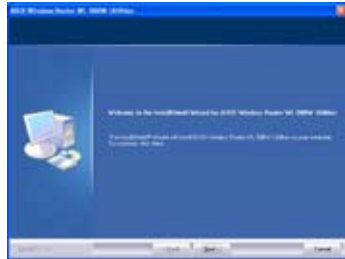

3. Click **Next** to install the utility in the designated location.
4. Select a program folder and click **Next**.



5. Press **Finish** to quit the installation program.
6. Open the **EZSetup Wizard**.

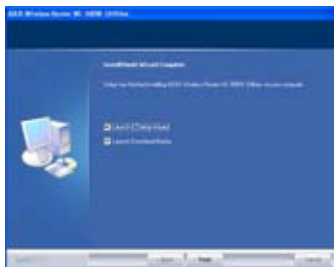



2) EZSetup

Wireless LAN setup will complete in two easy steps. First open the EZSetup utility from Start menu, then push the EZSetup button on the rear panel for 3 seconds.

- 1) Push **EZSetup** over 3 sec. and release.

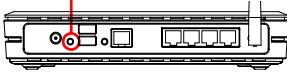

1) If the setup button is pushed without running the EZsetup wizard utility, the PWR indicator will flash and Internet connections will pause for a short period but will then return to normal operation without change.

2) To use EZSetup, we recommend using an ASUS wireless adapter such as WL-100W, WL-100gE, and WL-169gE.



Click the **EZSetup** button in the utility.

Note: Use EZSetup Wizard with one wireless client at a time. If the wireless client computer cannot discover the wireless router while in EZSetup mode, please shorten the distance between the client and the router.



Wireless settings, including network name and network keys, are generated automatically. You can modify these settings manually. Note if your wireless router is configured before, select **Preserve original wireless router settings** to use the current value. Click **Next** to continue.

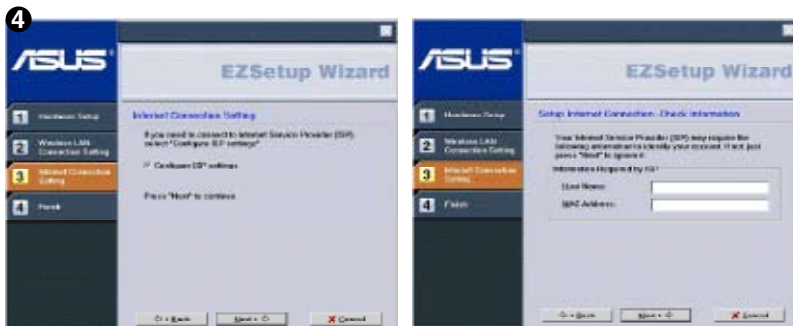

If you need to configure the ISP settings for your wireless router, select **Configure ISP settings**, click **Next** and follow the instructions to complete the settings.

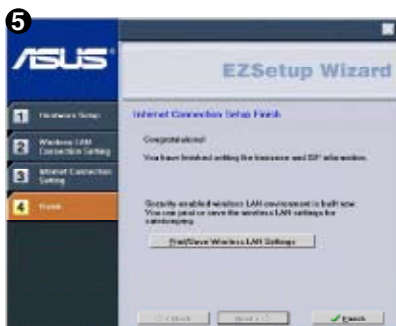

Setup is complete, press **Print/Save Wireless LAN Settings** button for future reference. Click **Finish** to exit the EZSetup utility.



7. Troubleshooting

Cannot access to web browser for router configuration



1. Open a web browser and open "Internet Options" dialog box.
2. Click on "Delete Cookies" and "Delete Files".

Cannot Establish Connection via Wireless

Out of Range:

- Put the router closer to the wireless client.
- Try to change the channel setting.

Authentication:

- Use wired connection to connect to router.
- Check the wireless security setting.
- Do the hard reset on the wireless router by pressing the Reset button on the rear panel for more than 5 seconds.

Couldn't find the router:

- Do the hard reset on the wireless router by pressing the Reset button on the rear panel for more than 5 seconds.
- Check the setting in the wireless adapter such as SSID and encryption setting.

Cannot get access to the Internet via wireless LAN adapter

- Move the router closer to the wireless client.
- Check whether the wireless adapter is connected to the correct AP.
- Check whether the wireless channel in use conforms to the channels available in your country/ area.
- Check encryption setting.
- Check whether the ADSL or Cable connection is correct.
- Retry using another Ethernet cable.



Internet is not accessible

- Check the lights on ADSL modem and the Wireless Router.
- Check whether the "WAN" LED on the Wireless Router is ON. If the LED is not ON, change the cable and try again.

When ADSL Modem "Link" light is ON (not blinking), this means Internet Access is Possible.

- Restart your computer.
- Refer to the Quick Setup Guide of the wireless router and reconfigure the settings.
- Check whether the WAN LED on the router is ON or not.
- Check wireless encryption settings.
- Check whether the computer can get the IP address or not (via both wired network and wireless network).
- Make sure your Web browser is configured to use the local LAN, and is not configured to use a proxy server.

If the ADSL "LINK" light blinks continuously or stays off, Internet access is not possible - the Router is unable to establish a connection with the ADSL network.

- Make sure your cables are all correctly connected .
- Disconnect the power cord from the ADSL or Cable modem, wait a few minutes, then reconnect the cord.
- If the ADSL light continues to blink or stays OFF, contact your ADSL service provider.

Network name or encryption keys are forgotten

- Try to setup the wired connection for setup the wireless encryption again.
- Do the hard reset on the wireless router by pressing the Reset button on the rear panel for more than 5 seconds.

How to reset to defaults

The following are factory default values. If you push the Restore button on the back of the ASUS Wireless Router for over 5 seconds, or click the "Restore" button on the "Factory Default" page under "Advanced Setup", the following default settings overwrite the old settings on your wireless router.

User Name:	admin	Subnet Mask:	255.255.255.0
Password:	admin	DNS Server 1:	192.168.1.1
Enable DHCP:	Yes (if plug in Wan cable)	DNS Server 2:	(Blank)
IP address:	192.168.1.1	SSID:	default
Domain Name:	(Blank)		



8. Appendix



FCC Warning Statement

This device complies with Part 15 of the FCC Rules. Operation is subject to the following two conditions:

- (1) this device may not cause harmful interference, and
- (2) this device must accept any interference received, including interference that may cause undesired operation.

This equipment has been tested and found to comply with the limits for a class B digital device, pursuant to part 15 of the FCC Rules. These limits are designed to provide reasonable protection against harmful interference in a residential installation.

This equipment generates, uses and can radiate radio frequency energy and, if not installed and used in accordance with the instructions, may cause harmful interference to radio communications. However, there is no guarantee that interference will not occur in a particular installation. If this equipment does cause harmful interference to radio or television reception, which can be determined by turning the equipment off and on, the user is encouraged to try to correct the interference by one or more of the following measures:

- Reorient or relocate the receiving antenna.
- Increase the separation between the equipment and receiver.
- Connect the equipment into an outlet on a circuit different from that to which the receiver is connected.
- Consult the dealer or an experienced radio/TV technician for help.



CAUTION:

Any changes or modifications not expressly approved by the party responsible for compliance could void the user's authority to operate the equipment.

Prohibition of Co-location

This device and its antenna(s) must not be co-located or operating in conjunction with any other antenna or transmitter.

Safety Information

To maintain compliance with FCC's RF exposure guidelines, this equipment should be installed and operated with minimum distance 20cm between the radiator and your body. Use on the supplied antenna.

Declaration of Conformity for R&TTE directive 1999/5/EC

Essential requirements – Article 3

Protection requirements for health and safety – Article 3.1a



Testing for electric safety according to EN 60950-1 has been conducted. These are considered relevant and sufficient.

Protection requirements for electromagnetic compatibility – Article 3.1b

Testing for electromagnetic compatibility according to EN 301 489-1 and EN 301 489-17 has been conducted. These are considered relevant and sufficient.

Effective use of the radio spectrum – Article 3.2

Testing for radio test suites according to EN 300 328- 2 has been conducted. These are considered relevant and sufficient.

CE **CE Mark Warning**



This is a Class B product, in a domestic environment, this product may cause radio interference, in which case the user may be required to take adequate measures.

GNU general public license

Licensing information

This product includes copyrighted third-party software licensed under the terms of the GNU General Public License. Please see The GNU General Public License for the exact terms and conditions of this license. We include a copy of the GPL with every CD shipped with our product. All future firmware updates will also be accompanied with their respective source code. Please visit our web site for updated information. Note that we do not offer direct support for the distribution.

GNU GENERAL PUBLIC LICENSE

Version 2, June 1991

Copyright (C) 1989, 1991 Free Software Foundation, Inc.

59 Temple Place, Suite 330, Boston, MA 02111-1307 USA

Everyone is permitted to copy and distribute verbatim copies of this license document, but changing it is not allowed.

Preamble

The licenses for most software are designed to take away your freedom to share and change it. By contrast, the GNU General Public License is intended to guarantee your freedom to share and change free software--to make sure the software is free for all its users. This General Public License applies to most of the Free Software Foundation's software and to any other program whose authors commit to using it. (Some other Free Software Foundation software is covered by the GNU Library General Public License instead.) You can apply it to your programs, too.

When we speak of free software, we are referring to freedom, not price. Our General Public Licenses are designed to make sure that you have the freedom to distribute copies of free software (and charge for this service if you wish), that you receive source code or can get it if you want it, that you can change the software or use pieces of it in new free programs; and that you know you can do these things.



To protect your rights, we need to make restrictions that forbid anyone to deny you these rights or to ask you to surrender the rights. These restrictions translate to certain responsibilities for you if you distribute copies of the software, or if you modify it.

For example, if you distribute copies of such a program, whether gratis or for a fee, you must give the recipients all the rights that you have. You must make sure that they, too, receive or can get the source code. And you must show them these terms so they know their rights.

We protect your rights with two steps: (1) copyright the software, and (2) offer you this license which gives you legal permission to copy, distribute and/or modify the software.

Also, for each author's protection and ours, we want to make certain that everyone understands that there is no warranty for this free software. If the software is modified by someone else and passed on, we want its recipients to know that what they have is not the original, so that any problems introduced by others will not reflect on the original authors' reputations.

Finally, any free program is threatened constantly by software patents. We wish to avoid the danger that redistributors of a free program will individually obtain patent licenses, in effect making the program proprietary. To prevent this, we have made it clear that any patent must be licensed for everyone's free use or not licensed at all.

The precise terms and conditions for copying, distribution and modification follow.

Terms & conditions for copying, distribution, & modification

0. This License applies to any program or other work which contains a notice placed by the copyright holder saying it may be distributed under the terms of this General Public License. The "Program", below, refers to any such program or work, and a "work based on the Program" means either the Program or any derivative work under copyright law: that is to say, a work containing the Program or a portion of it, either verbatim or with modifications and/or translated into another language. (Hereinafter, translation is included without limitation in the term "modification".) Each licensee is addressed as "you".

Activities other than copying, distribution and modification are not covered by this License; they are outside its scope. The act of running the Program is not restricted, and the output from the Program is covered only if its contents constitute a work based on the Program (independent of having been made by running the Program). Whether that is true depends on what the Program does.

1. You may copy and distribute verbatim copies of the Program's source code as you receive it, in any medium, provided that you conspicuously and appropriately publish on each copy an appropriate copyright notice and disclaimer of warranty; keep intact all the notices that refer to this License and to the absence of any warranty; and give any other recipients of the Program a copy of this License along with the Program.

You may charge a fee for the physical act of transferring a copy, and you may at your option offer warranty protection in exchange for a fee.

2. You may modify your copy or copies of the Program or any portion of it, thus forming a work based on the Program, and copy and distribute such modifications or work under the terms of Section 1 above, provided that you also meet all of these conditions:

a) You must cause the modified files to carry prominent notices stating that you changed the files and the date of any change.



b) You must cause any work that you distribute or publish, that in whole or in part contains or is derived from the Program or any part thereof, to be licensed as a whole at no charge to all third parties under the terms of this License.

c) If the modified program normally reads commands interactively when run, you must cause it, when started running for such interactive use in the most ordinary way, to print or display an announcement including an appropriate copyright notice and a notice that there is no warranty (or else, saying that you provide a warranty) and that users may redistribute the program under these conditions, and telling the user how to view a copy of this License. (Exception: if the Program itself is interactive but does not normally print such an announcement, your work based on the Program is not required to print an announcement.)

These requirements apply to the modified work as a whole. If identifiable sections of that work are not derived from the Program, and can be reasonably considered independent and separate works in themselves, then this License, and its terms, do not apply to those sections when you distribute them as separate works. But when you distribute the same sections as part of a whole which is a work based on the Program, the distribution of the whole must be on the terms of this License, whose permissions for other licensees extend to the entire whole, and thus to each and every part regardless of who wrote it.

Thus, it is not the intent of this section to claim rights or contest your rights to work written entirely by you; rather, the intent is to exercise the right to control the distribution of derivative or collective works based on the Program.

In addition, mere aggregation of another work not based on the Program with the Program (or with a work based on the Program) on a volume of a storage or distribution medium does not bring the other work under the scope of this License.

3. You may copy and distribute the Program (or a work based on it, under Section 2) in object code or executable form under the terms of Sections 1 and 2 above provided that you also do one of the following:

a) Accompany it with the complete corresponding machine-readable source code, which must be distributed under the terms of Sections 1 and 2 above on a medium customarily used for software interchange; or,

b) Accompany it with a written offer, valid for at least three years, to give any third party, for a charge no more than your cost of physically performing source distribution, a complete machine-readable copy of the corresponding source code, to be distributed under the terms of Sections 1 and 2 above on a medium customarily used for software interchange; or,

c) Accompany it with the information you received as to the offer to distribute corresponding source code. (This alternative is allowed only for noncommercial distribution and only if you received the program in object code or executable form with such an offer, in accord with Subsection b above.)

The source code for a work means the preferred form of the work for making modifications to it. For an executable work, complete source code means all the source code for all modules it contains, plus any associated interface definition files, plus the scripts used to control compilation and installation of the executable. However, as a special exception, the source code distributed need not include anything that is normally distributed (in either source or binary form) with the major components (compiler, kernel, and so on) of the operating system on which the executable runs, unless that component itself accompanies the executable.



If distribution of executable or object code is made by offering access to copy from a designated place, then offering equivalent access to copy the source code from the same place counts as distribution of the source code, even though third parties are not compelled to copy the source along with the object code.

4. You may not copy, modify, sublicense, or distribute the Program except as expressly provided under this License. Any attempt otherwise to copy, modify, sublicense or distribute the Program is void, and will automatically terminate your rights under this License. However, parties who have received copies, or rights, from you under this License will not have their licenses terminated so long as such parties remain in full compliance.
5. You are not required to accept this License, since you have not signed it. However, nothing else grants you permission to modify or distribute the Program or its derivative works. These actions are prohibited by law if you do not accept this License. Therefore, by modifying or distributing the Program (or any work based on the Program), you indicate your acceptance of this License to do so, and all its terms and conditions for copying, distributing or modifying the Program or works based on it.
6. Each time you redistribute the Program (or any work based on the Program), the recipient automatically receives a license from the original licensor to copy, distribute or modify the Program subject to these terms and conditions. You may not impose any further restrictions on the recipients' exercise of the rights granted herein. You are not responsible for enforcing compliance by third parties to this License.
7. If, as a consequence of a court judgment or allegation of patent infringement or for any other reason (not limited to patent issues), conditions are imposed on you (whether by court order, agreement or otherwise) that contradict the conditions of this License, they do not excuse you from the conditions of this License. If you cannot distribute so as to satisfy simultaneously your obligations under this License and any other pertinent obligations, then as a consequence you may not distribute the Program at all. For example, if a patent license would not permit royalty-free redistribution of the Program by all those who receive copies directly or indirectly through you, then the only way you could satisfy both it and this License would be to refrain entirely from distribution of the Program.

If any portion of this section is held invalid or unenforceable under any particular circumstance, the balance of the section is intended to apply and the section as a whole is intended to apply in other circumstances.

It is not the purpose of this section to induce you to infringe any patents or other property right claims or to contest validity of any such claims; this section has the sole purpose of protecting the integrity of the free software distribution system, which is implemented by public license practices. Many people have made generous contributions to the wide range of software distributed through that system in reliance on consistent application of that system; it is up to the author/donor to decide if he or she is willing to distribute software through any other system and a licensee cannot impose that choice.

This section is intended to make thoroughly clear what is believed to be a consequence of the rest of this License.

8. If the distribution and/or use of the Program is restricted in certain countries either by patents or by copyrighted interfaces, the original copyright holder who places the Program under this License may add an explicit geographical distribution limitation excluding those countries, so that distribution is permitted only in or among countries not thus excluded. In such case, this License incorporates the limitation as if written in the body of this License.



9. The Free Software Foundation may publish revised and/or new versions of the General Public License from time to time. Such new versions will be similar in spirit to the present version, but may differ in detail to address new problems or concerns.

Each version is given a distinguishing version number. If the Program specifies a version number of this License which applies to it and “any later version”, you have the option of following the terms and conditions either of that version or of any later version published by the Free Software Foundation. If the Program does not specify a version number of this License, you may choose any version ever published by the Free Software Foundation.

10. If you wish to incorporate parts of the Program into other free programs whose distribution conditions are different, write to the author to ask for permission. For software which is copyrighted by the Free Software Foundation, write to the Free Software Foundation; we sometimes make exceptions for this. Our decision will be guided by the two goals of preserving the free status of all derivatives of our free software and of promoting the sharing and reuse of software generally.

NO WARRANTY

11. BECAUSE THE PROGRAM IS LICENSED FREE OF CHARGE, THERE IS NO WARRANTY FOR THE PROGRAM, TO THE EXTENT PERMITTED BY APPLICABLE LAW. EXCEPT WHEN OTHERWISE STATED IN WRITING THE COPYRIGHT HOLDERS AND/OR OTHER PARTIES PROVIDE THE PROGRAM “AS IS” WITHOUT WARRANTY OF ANY KIND, EITHER EXPRESSED OR IMPLIED, INCLUDING, BUT NOT LIMITED TO, THE IMPLIED WARRANTIES OF MERCHANTABILITY AND FITNESS FOR A PARTICULAR PURPOSE. THE ENTIRE RISK AS TO THE QUALITY AND PERFORMANCE OF THE PROGRAM IS WITH YOU. SHOULD THE PROGRAM PROVE DEFECTIVE, YOU ASSUME THE COST OF ALL NECESSARY SERVICING, REPAIR OR CORRECTION.

12. IN NO EVENT UNLESS REQUIRED BY APPLICABLE LAW OR AGREED TO IN WRITING WILL ANY COPYRIGHT HOLDER, OR ANY OTHER PARTY WHO MAY MODIFY AND/OR REDISTRIBUTE THE PROGRAM AS PERMITTED ABOVE, BE LIABLE TO YOU FOR DAMAGES, INCLUDING ANY GENERAL, SPECIAL, INCIDENTAL OR CONSEQUENTIAL DAMAGES ARISING OUT OF THE USE OR INABILITY TO USE THE PROGRAM (INCLUDING BUT NOT LIMITED TO LOSS OF DATA OR DATA BEING RENDERED INACCURATE OR LOSSES SUSTAINED BY YOU OR THIRD PARTIES OR A FAILURE OF THE PROGRAM TO OPERATE WITH ANY OTHER PROGRAMS), EVEN IF SUCH HOLDER OR OTHER PARTY HAS BEEN ADVISED OF THE POSSIBILITY OF SUCH DAMAGES.

END OF TERMS AND CONDITIONS

DGT warning

經型式認證合格之低功率射頻電機，非經許可，公司、商號或使用者均不得擅自變更頻率、加大功率或變更原設計之特性及功能。

低功率射頻電機之使用不得影響飛航安全及干擾合法通信；經發現有干擾現象時，應立即停用，並改善至無干擾時方得繼續使用。

前項合法通信，指依電信法規定作業之無線電通信。

低功率射頻電機須忍受合法通信或工業、科學及醫療用電波輻射性電機設備之干擾。